

From the 1600's to the 1900's

*The migration of Sam Henson  
Floyd's Baugh line ancestors  
inside the  
North American Continent*

# Descriptions of the following pages

- Slide 1 shows the earliest entry into the Colonies.
- Slides 2 through 3 show the migration of the Baugh line making their way to Texas.
- Slide 4 has a map overview of the migration path.

# Baugh line 1600 to 1700 first landing in the Colonies

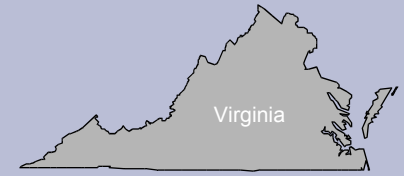

Slide  
1

1600                      1625                      1650                      1675                      1700



Garret line in  
VA by 1655.

Baugh line in  
Virginia until  
around 1765.

Slide  
2

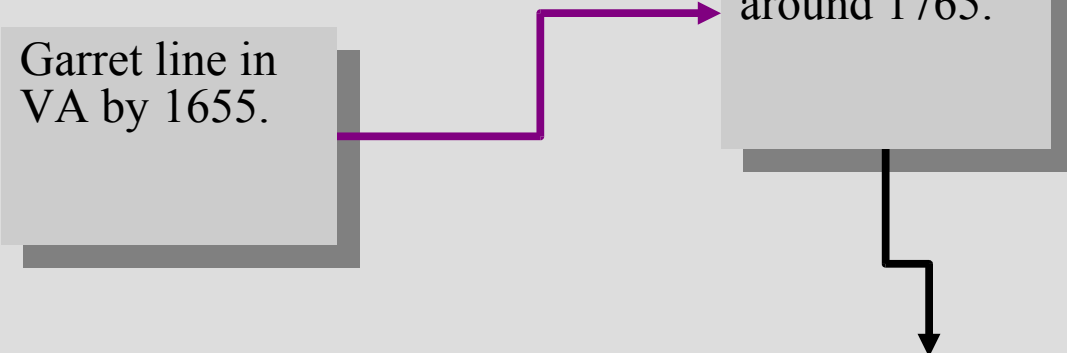

Slide  
2

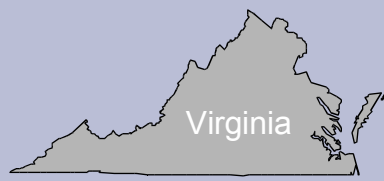

Slide  
1

Baugh line was in SC  
about 1765.

Baugh line was in SC  
until no later than 1803  
when David Baugh was  
born in GA.

Slide  
3



Slide 3

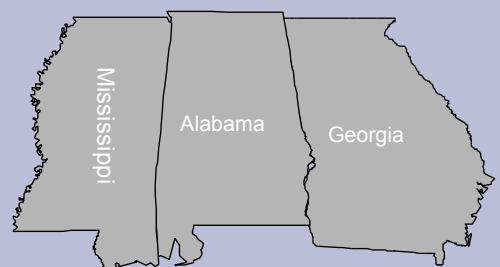

1800

1825

1850

1875

1900

Slide 2

David Baugh is born in GA 9 Dec 1803.

Then in Mississippi by 1842.

He and his wife Pency are in Alabama by 1839.

Then in Texas by 1844.

Their daughter Amazon marries Samuel Windham in 1872 Brown Co., TX

More information is in the Windham line file.

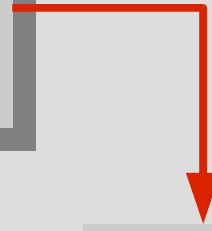
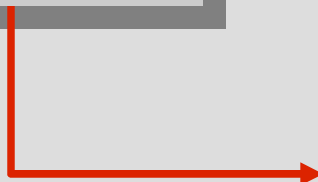
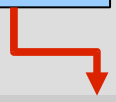

# The Baugh Line Migration

Slide  
4

